

Assembly and Maintenance Manual

Type RSBW



Hatschekstr. 36
69126 Heidelberg
Germany
Tel +49(0)6221 30470
Tel +49(0)6221 304731
info@stieber.de
www.stieber.de

Stieber Clutch
Date of issue: 16/03/2017 GB
Revision: 0

U:\EngUsers\IProduktDoku\1AAA_Einbauerklärung_Montage-und Wartungsanleitung_Konformitätserklärung\1AAA_Montage- und Wartungsanleitungen\Original_Worddatei\M1042E_0_RSBW.docx



General safety instructions





	WARNING	<p>Risk of injury due to moving components! Rotating driven components can cause severe injuries. Therefore, during operation:</p> <ul style="list-style-type: none"> ➤ It is strictly forbidden for persons to loiter in the hazard area or in its immediate vicinity ➤ Do not disable, render unusable, or circumvent safety equipment and/or safety functions. <p>Prior to entering the hazard area:</p> <ul style="list-style-type: none"> ➤ Switch off the power supply and secure it against being switched on again ➤ Wait for still moving components to come to a standstill
	DANGER!	<p>Danger due to improper operation!</p> <ul style="list-style-type: none"> ➤ Modifications to the one-way clutch are not permitted and may impair safety ➤ All tasks may only be performed by personnel with the requisite training and expertise ➤ Repairs and maintenance tasks may only be performed when the machine is at a standstill. The machine is therefore to be secured against a restart
	WARNING	<p>Risk of injury due to the one-way clutch falling down or tipping over! The weight of the one-way clutch can injure people and cause severe crushing. Therefore:</p> <ul style="list-style-type: none"> ➤ When lifting, use suitable lifting gear (slings, etc.) able to support the weight of the one-way clutch
	WARNING	<p>Risk of injury due to incorrect assembly! Faulty installation and maintenance can cause severe property damage and personal injury. Installation, maintenance, and repair work may only be performed by personnel with the requisite training and expertise.</p>
	WARNING	<p>Risk of injury for insufficiently qualified personnel! Improper handling can cause significant personal injury and property damage. Therefore:</p> <ul style="list-style-type: none"> ➤ Only ever have tasks performed by those persons to whom the tasks have been assigned

Table of contents	Page
General safety instructions	2
1 General	4
1.1 Information relating to the assembly and maintenance manual.....	4
1.2 Explanation of symbols	4
1.3 Manufacturer.....	5
1.4 Labeling	5
1.5 Environmental protection	5
2 Safety	5
2.1 Intended use	5
2.2 Responsibility of the operator	6
2.3 Assembly and maintenance personnel	6
2.4 Personal protective equipment	7
2.5 Limitations of use	7
3 Structure and function	8
3.1 Structure	8
3.2 Functional principle	9
4 Transport and packaging	9
5 Storage	10
5.1 Short-term storage	10
5.2 Long-term storage.....	10
6 Installation	11
6.1 Checking the direction of rotation	11
6.2 Changing the direction of rotation	11
6.3 Lubrication	11
6.4 Assembly	11
6.5 Installation example	13
7 Maintenance	13
8 Disassembly	14
9 Disposal	15
10 Faults	15

1 General

1.1 Information relating to the assembly and maintenance manual

This assembly and maintenance manual provides important information regarding the installation and commissioning of the one-way clutches of the type RSBW.





The prerequisite for safe operation is compliance with all of the stated safety and handling instructions.

Moreover, the relevant local accident protection guidelines and general safety provisions for the field of application of the one-way clutch are to be complied with.

Read the assembly and maintenance manual carefully prior to installation and commissioning. The manual is a product component and must be kept in the immediate vicinity of the installation site and be accessible to personnel at all times. Furthermore, all safety instructions stated in the assembly and maintenance manual are to be observed.

1.2 Explanation of symbols

Warnings are marked throughout this assembly and maintenance manual by symbols. These warnings are introduced by signal words that indicate the extent of the danger. Comply with the warnings under all circumstances and act with due care and attention to avoid accidents, personal injury, and property damage.

	DANGER!	...indicates an imminently dangerous situation that can be fatal or cause severe injuries if it is not averted.
	WARNING	...indicates a potentially dangerous situation that can be fatal or cause severe injuries if it is not averted.
	ATTENTION	...indicates a potentially dangerous situation that can cause minor or light injuries if it is not averted.
	CAUTION	...indicates a potentially dangerous situation that can cause property damage if it is not averted.
	NOTICE	...highlights helpful tips and recommendations as well as information for efficient and trouble-free operation.

1.3 Manufacturer

STIEBER GMBH, D-69126 Heidelberg, Hatschekstr. 36, Germany
Tel +49 (0) 6221 3047-0, Fax -31

1.4 Labeling

Front of the inner ring

- Manufacturer
- Type designation
- Date of manufacture (coded)

1.5 Environmental protection

Energy: The one-way clutch does not use any electrical energy

Materials: Steel

Recycling: Steel parts are up to 100% recyclable

2 Safety

2.1 Intended use

One-way clutches of type RSBW are automatically switching couplings dependent on the direction of rotation. They are used as backstops or switching clutches in machines and systems.

One-way clutches may only be operated within the limitations of use outlined in section 2.5.

All of the specifications stated in the assembly and maintenance manual must be strictly adhered to.

Any claims due to damage arising from improper use are excluded. The operator bears sole liability for all damage arising from improper use.

Lockout operation of a backstop:

When the machine shaft is operated in the reverse direction, the machine shaft and the torque-supporting machine element are connected to each other in a force-locked manner by the one-way clutch. In this operating state, a torque is transmitted.

Overrun operation of a backstop:

The one-way clutch automatically releases the force-locked connection between the machine shaft and the torque-supporting machine element, providing the machine shaft is operated in the overrun direction.

Driving operation of an indexing clutch:

When the machine shaft is operated in the pulling direction, the machine shaft and the torque-supporting machine element are connected to each other in a force-locked manner by the one-way clutch. In this operating state, an output is transmitted.

Idling operation of an indexing clutch:

The one-way clutch automatically releases the force-locked connection between the machine shaft and the torque-supporting machine element, providing the machine shaft is operated in the idling direction.

2.2 Responsibility of the operator

The operator of the system in which the one-way clutch is installed is subject to the legal obligations concerning occupational safety.

The valid provisions for the site of operation as well as the safety and accident prevention regulations of the trade association are to be observed. In particular, this means that the operator:

- is aware of the valid occupational safety provisions
- implements at the site of operation the necessary behavioral requirements for operation of the machine in which the one-way clutch is installed
- clearly defines responsibilities for installation, operation, maintenance, and cleaning of the machine in which the one-way clutch is installed
- ensures that all staff members who work at or with the machine in which the one-way clutch is installed have read and understood the operation manual. Moreover, the operator must, at regular intervals, provide training for personnel on how to handle the machine in which the one-way clutch is installed, and inform them of the potential dangers. In addition, the operator is responsible for ensuring that the system in which the one-way clutch is installed:
 - is always in perfect technical condition
 - is maintained in accordance with the specified maintenance intervals
 - has all its safety equipment checked regularly for completeness and functionality

2.3 Assembly and maintenance personnel

	WARNING	<p>Risk of injury for insufficiently qualified personnel! Improper handling can cause significant personal injury and property damage. Therefore:</p> <ul style="list-style-type: none"> ➤ Only ever have tasks performed by those persons to whom the tasks have been assigned
---	----------------	---

Qualified personnel are those persons who, owing to their training, experience and instruction as well as their knowledge of relevant standards, provisions, accident prevention regulations and operating conditions, have been authorized by the person responsible for the safety of the system to perform the requisite tasks and are able to recognize and avoid

potential dangers in doing so. Knowledge of first-aid measures and on-site emergency equipment are also required.

2.4 Personal protective equipment

In order to minimize health risks, it is necessary to wear personal protective equipment when handling the machine in which the one-way clutch is installed.

Above all, the necessary protective equipment such as work shoes, gloves, safety goggles, etc. is to be put on prior to all tasks and kept on during the task.

2.5 Limitations of use

- Maximum permissible overrun rotation speeds and maximum permissible torques

Type	Dimensions	Max. torque [Nm]	Max. overrun rotation speed Inner ring [rpm]	Max. overrun rotation speed Outer ring [rpm]
RSBW	20	750	400	–
	25	1212	400	–
	30	1212	400	–
	35M	750	400	–
	35	1212	400	–
	40	2590	300	–
	45	2590	300	–
	50	2590	300	–
	55	2590	300	–
	60	5100	250	–
	70	5100	250	–
	80	9750	200	–
	90	9750	200	–
100	9750	200	–	

Table 1 Specifications



NOTICE

If the hole diameter is smaller than the maximum, the maximum torque to be transmitted depends on the fitting key connection.

- Limits for ambient temperature: -15°C (5°F) to +50°C (122°F)
- Max. operating temperature: 90°C (194°F)
- Machine shaft tolerance: d = h6 or j6

- Bolt play must lie within 1-3% of the elongated hole width
- Lifetime lubrication: Klübersynth Poly Lup WH2

3 Structure and function

3.1 Structure

Pos. 1	Fixed ring
Pos. 2	I-ring
Pos. 4	Cage clutch
Pos. 7	Bearing washer
Pos. 8	Locking ring
Pos. 9	Washer
Pos. 12	O-Ring

Table 2 Parts list

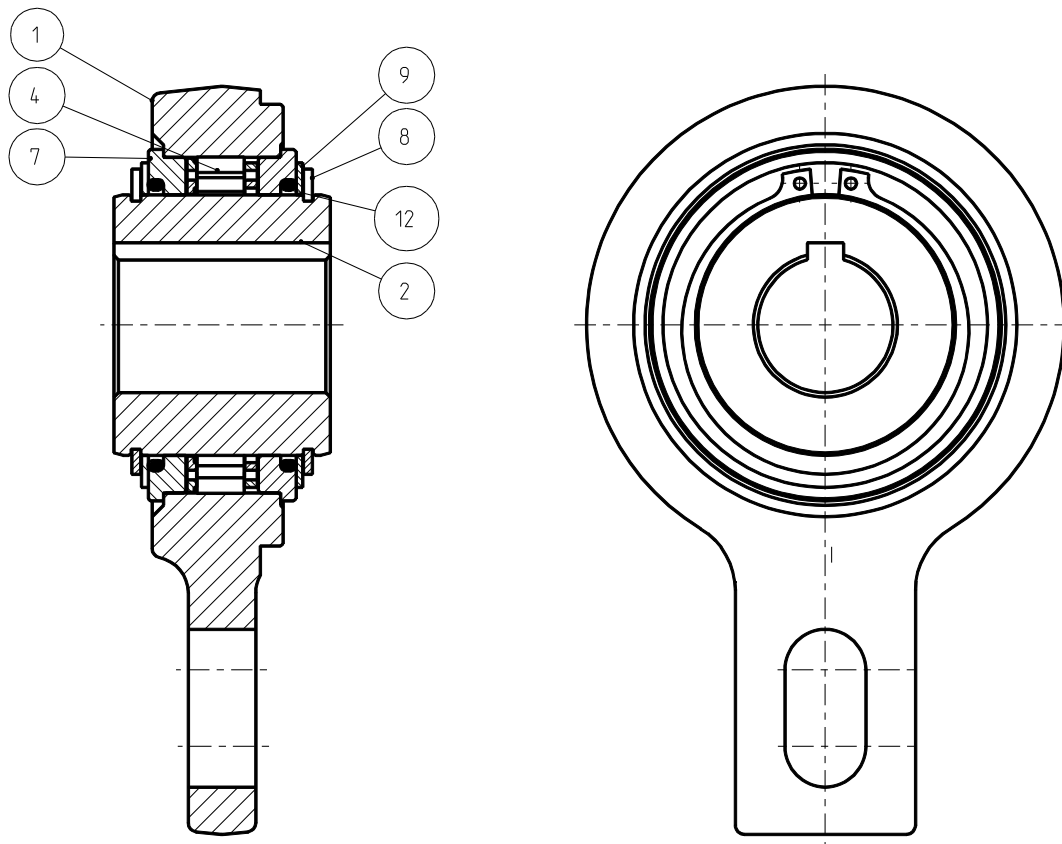

Fig. 1 Structure of one-way clutch RSBW

3.2 Functional principle

One-way clutches of the model RSBW are fitted with individually spring-loaded sprags.

When turning the inner or outer clutch ring (see Fig. 2) in the pulling direction, the sprags create a frictional connection between the inner and outer ring so that a torque or output can be transmitted.

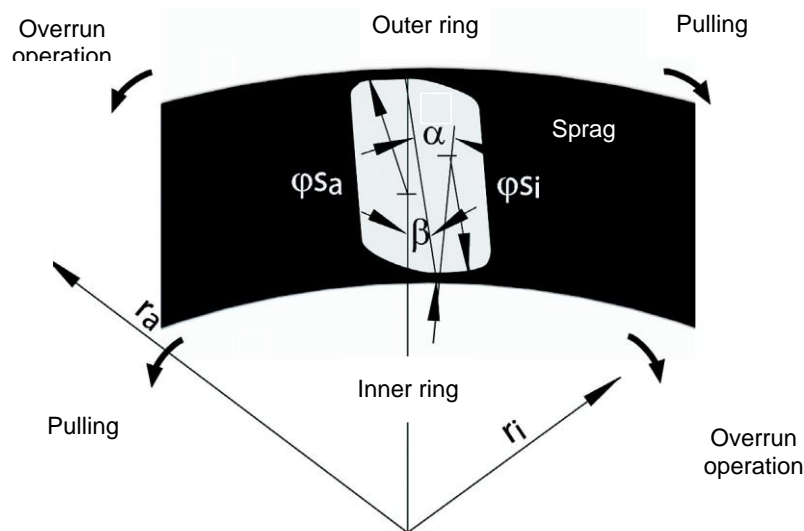

Fig. 2 Pulling/Overrun operation

Overrun operation is carried out if the inner or outer ring is turned in the overrun direction. This interrupts the frictional connection (see Fig. 2) between the inner and outer ring. In overrun operation the speeds of the inner ring and outer ring are different.

4 Transport and packaging



NOTICE

The local provisions regarding the disposal of transport and packaging materials are to be observed.

The one-way clutch is shrink-wrapped in PVC film and shipped in a box with packaging filler material.

Transport damage to the packaging and/or the one-way clutch is to be reported to the respective transit company without delay.

The one-way clutch must be unpacked in a clean and dry environment.

5 Storage

5.1 Short-term storage

RSBW one-way clutches come with an oil film as corrosion protection. This corrosion protection is to be renewed at regular intervals. The frequency of these renewal intervals is dependent on the environmental conditions (temperature, moisture, salt content of the air, etc.) at the storage site.

The maximum storage period (short-term storage) is 6 months. Moreover, the one-way clutch must have long-term storage corrosion protection applied to it.

When storing, it is essential to ensure that the grease remains evenly distributed in the one-way clutch. Storage in a horizontal position results in the grease flowing gradually out of the upper bearing toward the bottom. For this reason, the one-way clutch should be turned several times during the storage period and carefully run in shortly before assembly.



NOTICE

Shortly before the assembly the one-way clutch must be carefully run in!

Store packages under the following conditions:

- Do not keep outdoors.
- Keep dry and free from dust.
- Do not expose to aggressive media.
- Keep away from direct sunlight.
- Avoid mechanical shocks and vibrations.
- Storage temperature: -10 to $+60^{\circ}\text{C}$ (14°F to 140°F)
- Relative humidity: max. 95%, non-condensing

5.2 Long-term storage

For long-term storage, the one-way clutch must be shrink-wrapped with a desiccant and provided with a hygroscope. The corrosion protection must be checked after a period not exceeding one year or else depending on the environmental conditions (temperature, moisture, salt content of the air, etc.) at the storage site.

Store packages under the following conditions:

- Do not keep outdoors
- Keep dry and free from dust
- Do not expose to aggressive media
- Keep away from direct sunlight
- Avoid mechanical shocks and vibrations

- Storage temperature: -10 to +60°C (14°F to 140°F)
- Relative humidity: max. 95%, non-condensing

6 Installation

6.1 Checking the direction of rotation

Before installation, the direction of rotation of the one-way clutch must be checked.



6.2 Changing the direction of rotation

The direction of rotation can be changed by turning the one-way clutch over.

6.3 Lubrication

The one-way clutch comes filled with a lifetime grease supply (Klüber Polylob WH2).

6.4 Assembly

	<p>WARNING</p>	<p>Risk of injury due to incorrect assembly!</p> <p>Faulty installation and maintenance can cause severe property damage and personal injury.</p> <p>Installation, maintenance, and repair work may only be performed by personnel with the requisite training and expertise.</p>
	<p>WARNING</p>	<p>Risk of injury due to moving components!</p> <p>Rotating driven components can cause severe injuries. Therefore, during operation:</p> <ul style="list-style-type: none"> ➤ It is strictly forbidden for persons to loiter in the hazard area or in its immediate vicinity ➤ Do not disable, render unusable, or circumvent safety equipment and/or safety functions <p>Prior to entering the hazard area:</p> <ul style="list-style-type: none"> ➤ Switch off the power supply and secure it against being switched on again ➤ Wait for still moving components to come to a standstill
	<p>WARNING</p>	<p>Risk of injury due to falling components!</p> <p>Falling components can lead to serious injuries to persons!</p> <p>Secure the one-way clutch against falling down.</p>

**WARNING****Risk of injury for insufficiently qualified personnel!**

Improper handling can cause significant personal injury and property damage. Therefore:

- Only ever have tasks performed by those persons to whom the tasks have been assigned

**NOTICE**

Shortly before the assembly the one-way clutch must be carefully run in!

Procedural steps:

- Insert supporting fitting key according to DIN 6885 Sheet 1 over the entire length of the one-way clutch in the shaft
- Push one-way clutch onto the oiled machine shaft, attaching suitable lifting equipment if necessary

**NOTICE**

Only press on the inner ring when pressing the one-way clutch onto the shaft.

- Fasten the one-way clutch axially on the machine shaft
- Seat torque bolts on the lever arm with about 1-3% bolt play

**NOTICE**

The torque support and the slide bearings should not be subjected to stress!

6.5 Installation example

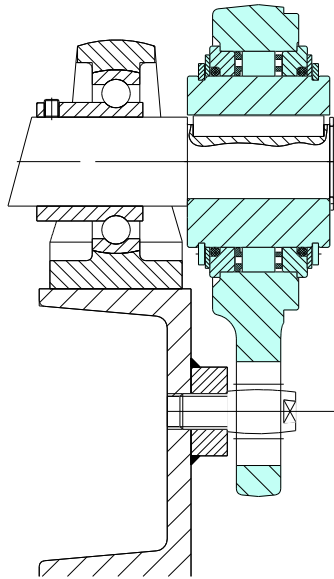





Fig. 5a: Installation example RSBW

7 Maintenance

	<p>WARNING</p>	<p>Risk of injury due to moving components! Rotating driven components can cause severe injuries. Therefore, during operation:</p> <ul style="list-style-type: none"> ➤ It is strictly forbidden for persons to loiter in the hazard area or in its immediate vicinity ➤ Do not disable, render unusable, or circumvent safety equipment and/or safety functions <p>Prior to entering the hazard area:</p> <ul style="list-style-type: none"> ➤ Switch off the power supply and secure it against being switched on again ➤ Wait for still moving components to come to a standstill
	<p>WARNING</p>	<p>Risk of injury due to incorrect assembly! Faulty installation and maintenance can cause severe property damage and personal injury. Installation, maintenance, and repair work may only be performed by personnel with the requisite training and expertise.</p>

	WARNING	<p>Risk of injury due to falling components! Falling components can lead to serious injuries to persons! Secure the one-way clutch against falling down.</p>
---	----------------	---

	WARNING	<p>Risk of injury for insufficiently qualified personnel! Improper handling can cause significant personal injury and property damage. Therefore:</p> <ul style="list-style-type: none"> ➤ Only ever have tasks performed by those persons to whom the tasks have been assigned
---	----------------	---

RSBW one-way clutches are maintenance-free.

8 Disassembly

	WARNING	<p>Risk of injury due to incorrect assembly! Faulty installation and maintenance can cause severe property damage and personal injury. Installation, maintenance, and repair work may only be performed by personnel with the requisite training and expertise.</p>
---	----------------	--

	WARNING	<p>Risk of injury due to moving components! Rotating driven components can cause severe injuries. Therefore, during operation:</p> <ul style="list-style-type: none"> ➤ It is strictly forbidden for persons to loiter in the hazard area or in its immediate vicinity ➤ Do not disable, render unusable, or circumvent safety equipment and/or safety functions <p>Prior to entering the hazard area:</p> <ul style="list-style-type: none"> ➤ Switch off the power supply and secure it against being switched on again ➤ Wait for still moving components to come to a standstill
---	----------------	---

	WARNING	<p>Risk of injury for insufficiently qualified personnel! Improper handling can cause significant personal injury and property damage. Therefore:</p> <ul style="list-style-type: none"> ➤ Only ever have tasks performed by those persons to whom the tasks have been assigned.
---	----------------	--

**WARNING****Risk of injury due to falling components!**

Falling components can lead to serious injuries to persons!
Secure the one-way clutch against falling down.

Procedural steps:

- Remove the axial fastening of the inner ring (2)
- Carefully pull the one-way clutch from the machine shaft with an extractor tool placed on the inner ring, using suitable lifting equipment, if required

**NOTICE**

Pulling on the outer ring will damage the one-way clutch!

9 Disposal

**NOTICE**

The local provisions regarding the disposal of metallic components and any lubricants present are to be observed.

The one-way clutch is comprised of metallic materials that are coated with grease or oil. Metallic materials are fully recyclable. Lubricants and anticorrosive agents are to be disposed of separately. The local disposal provisions are to be observed in this regard.

10 Faults

The manufacturer is to be contacted immediately should any faults arise.

STIEBER GMBH, D-69126 Heidelberg, Hatschekstr. 36, Germany
Tel +49 (0) 6221 3047-0, Fax -31